

# Ice Oddities

Sara Yancey

Virginia Tech (VPISU)

Eliz Fenstermacher

Mount Holyoke College

Summer 2003 REU

University of Washington

Advisor Jerry Seidler

# Outline

- **Introduction**
- **Theory**
- **Apparatus**
- **Conclusions**



# Why is water groovy?

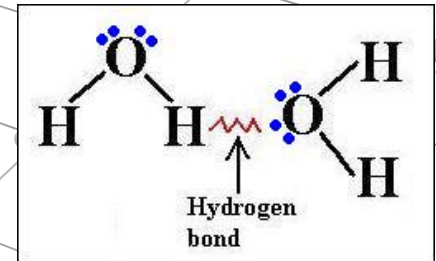
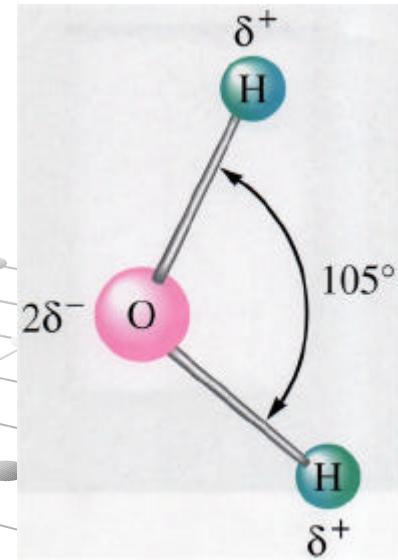
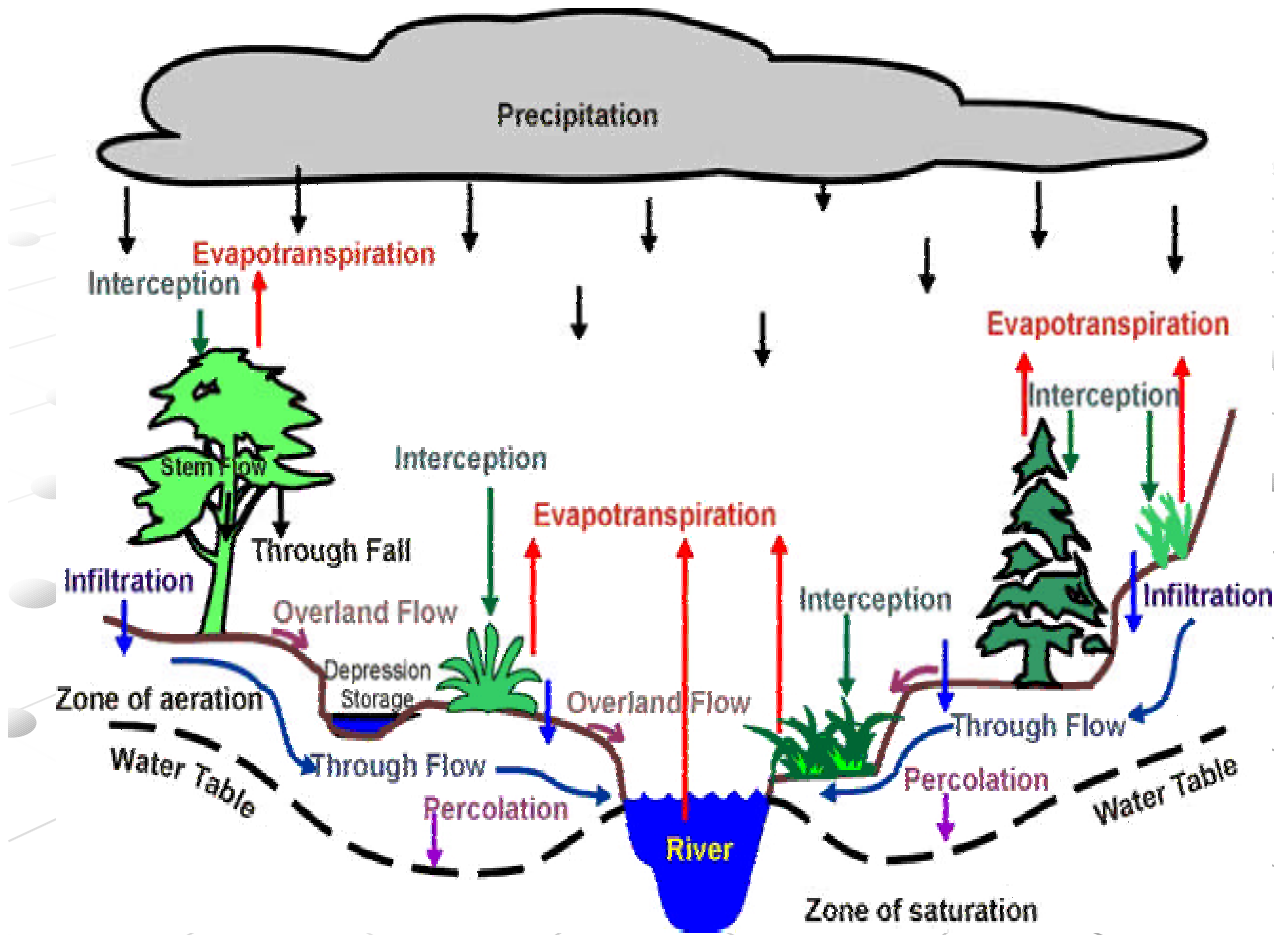

# Thermocouples

$$V = (T_H - T_C)$$

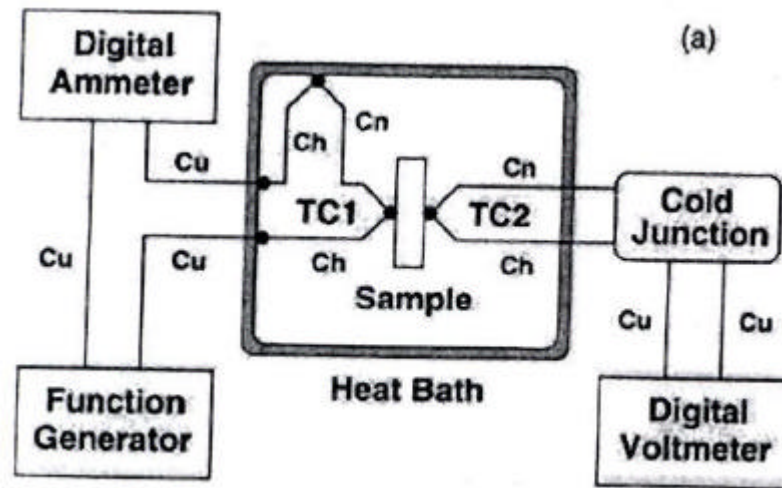
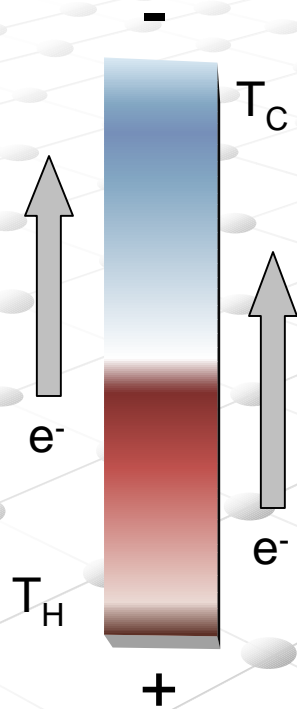



feed through box for vacuum attachment and wires

1/2" thin walled SS tube

4" glass dewar

cryostat

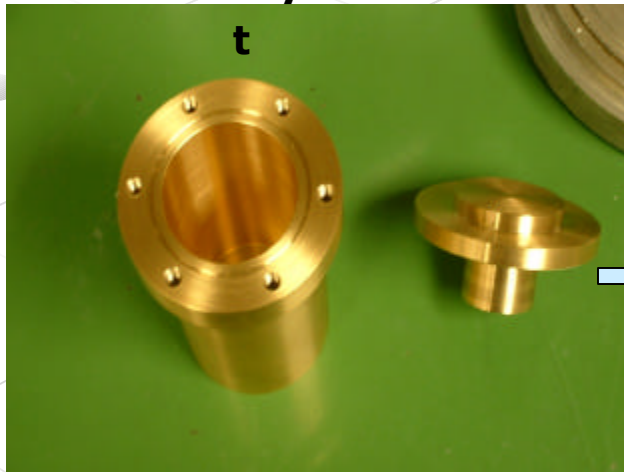

patient Ron top plate with cajon fitting, N<sub>2</sub> release, Cu feedthroughs

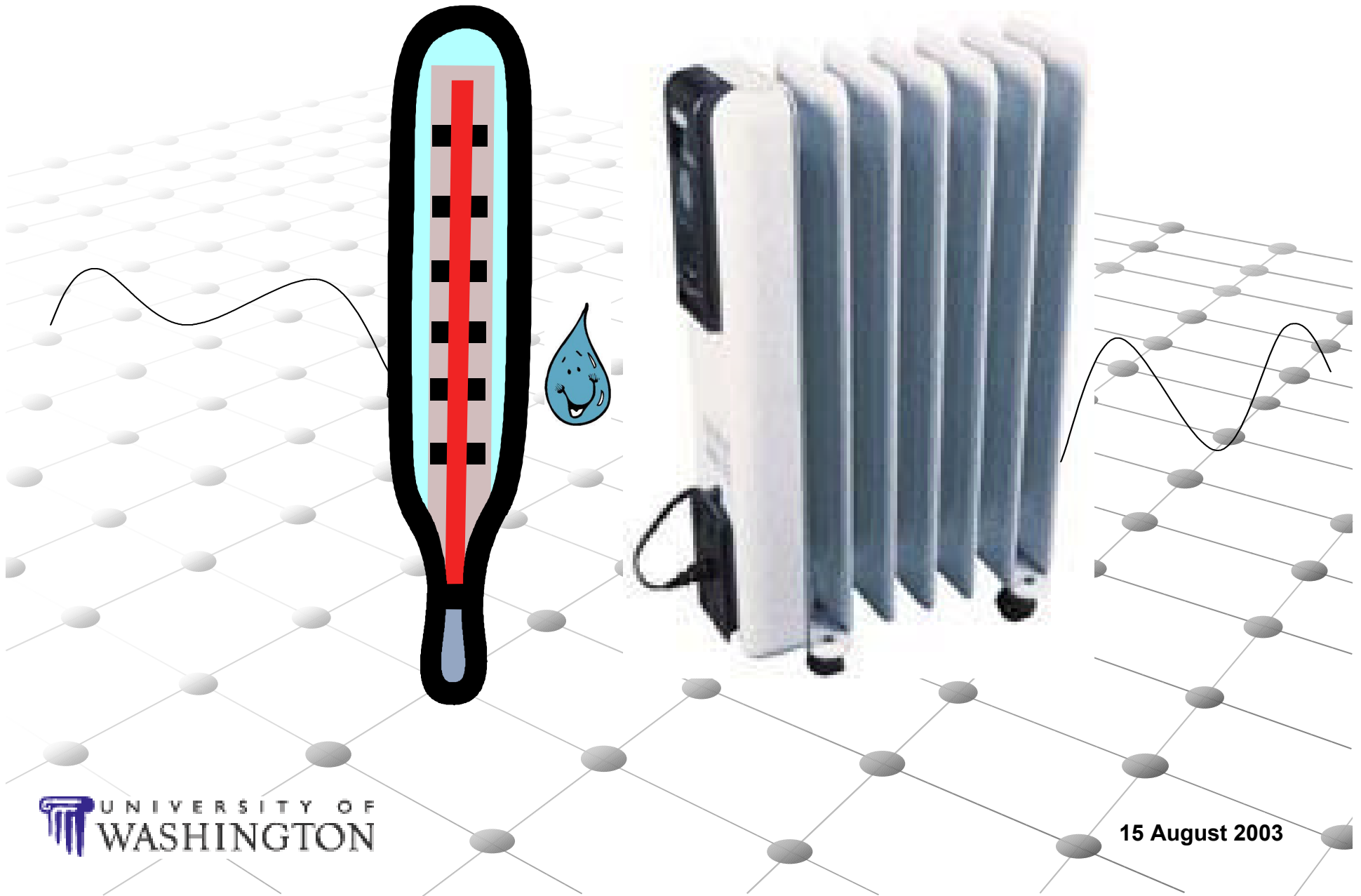

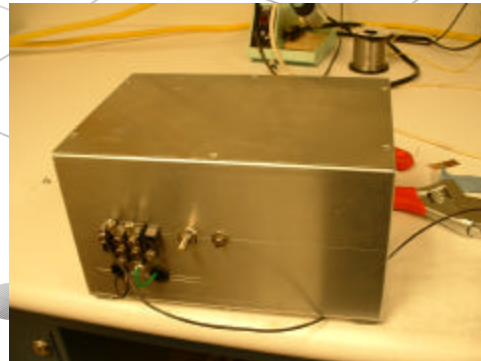
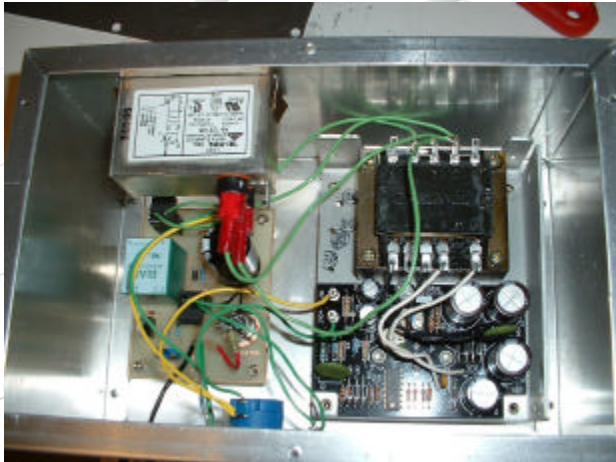
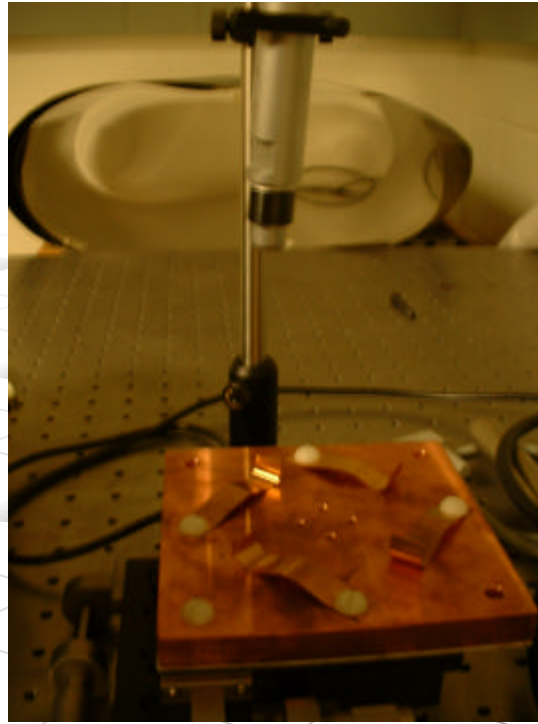

# spire w-e red-e r

# Cells

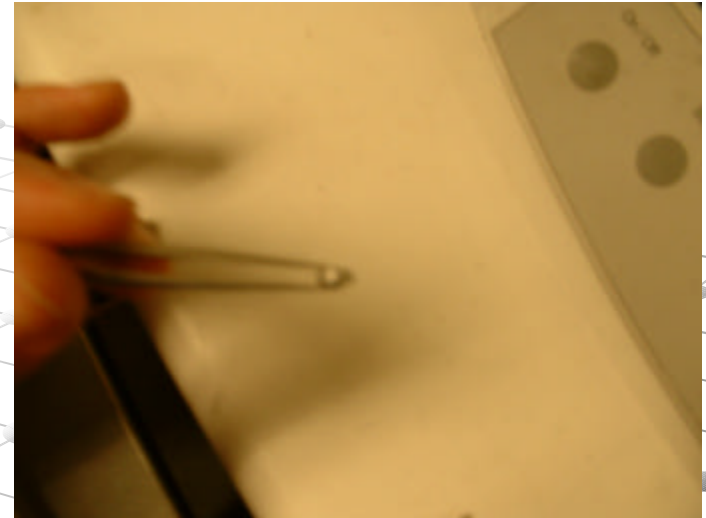



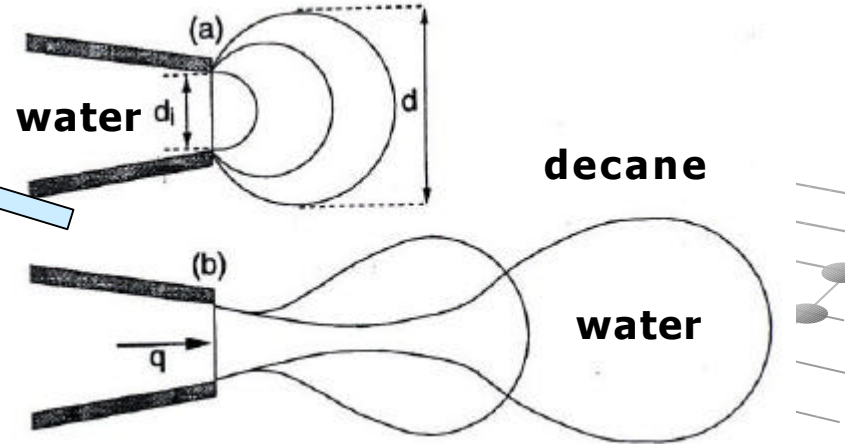
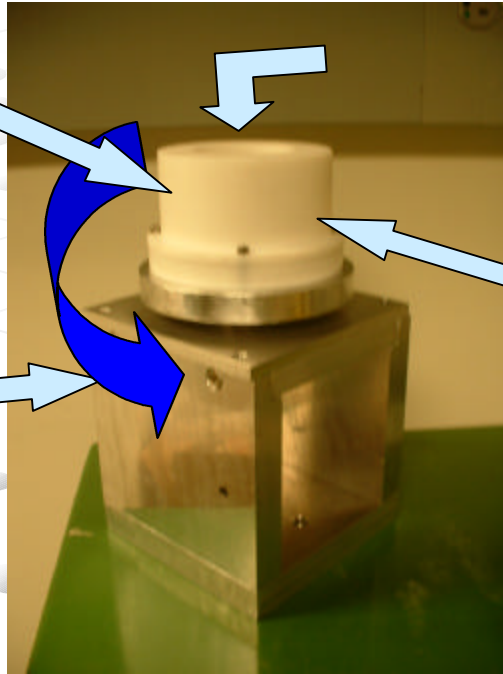
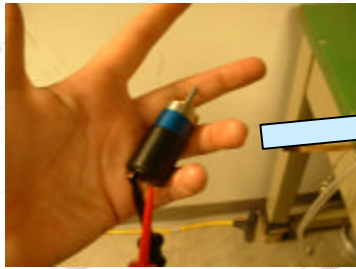
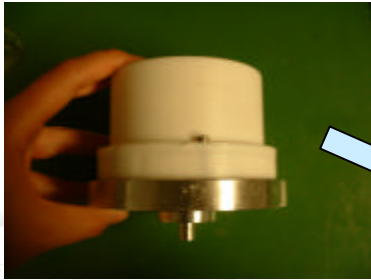

# Results /Conclusions/Future

- **Setup complete**
- **Need data!**

# Acknowledgements

**We would like to thank the NSF, Jerry Seidler, Lane Seeley, Ron, Mike, Ted, Jim..., Bryan Venema, Lesley Reece and the H-bar guy.**

